

RAISE A GREEN WORLD

# Solar Racking Component

Catalogue 2022

✉ [australia@antaisolar.com](mailto:australia@antaisolar.com)

📍 30F, W Square, 1801 Huandao East Road, Siming District, Xiamen, China

🌐 <https://www.antaisolar.com>



# Contents

Antai Anodized Rail	01
ATL-DR-JOINER	02
ATL-IK-TIN	03
ATL-IK-TILE	04
ATL-AD-FL	05
ATL-AD-RL-15/30	06
ATL-AD-RL-10/15	07
ATL-IK-700	08
ATL-IK-406	09
ATL-IC-35/40	10
ATL-IC-35/40-B	11
ATL-EC-35/40-B	12
ATL-EC-35/40	13
ALT-EC-32	14
ALT-EC-42	15
ALT-IC-42	16
ATL-DR-Nut	17
ATL-G-EC	18
ATL-CT-2	19
ATL-G-GL	20
ATL-Tin-1500-35/40	21
ATL-Tin-2000-35/40	22
ATL-Tile-1500-35/40	23
ATL-Tile-2000-35/40	24
ATL-Clamp-6P-42	25
ATL-Clamp-8P-42	26

# Antai Anodized Rail

# ATL-DR-JOINER

Product CODE	ATL-DR-355-L4400
Product Name	Antai Anodized Rail Type VI 4400mm (TYN-355-L4400) New
MATERIAL	AL6005-T6
SURFACE TREATMENT	ANODIZING 10um
Length	4400mm
Color	Silver/Black

Product CODE	ATL-DR-JOINER
Product Name	Antai T Universal Rail Splice
MATERIAL	AL6005-T6 & SS304 Bolt
SURFACE TREATMENT	ANODIZING 10um
Package	200pcs/carton, 530*330*330mm
Weight	0.15KG/PC
Length	150mm
Contents	2x M8 bolt (25mm) & earthing washers

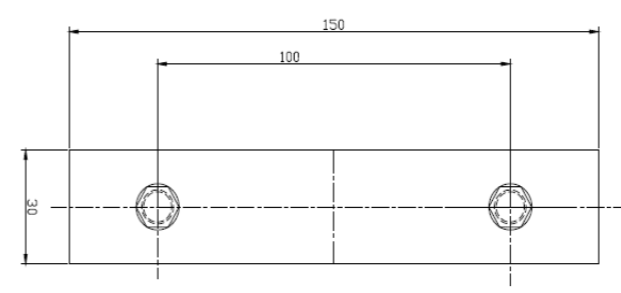
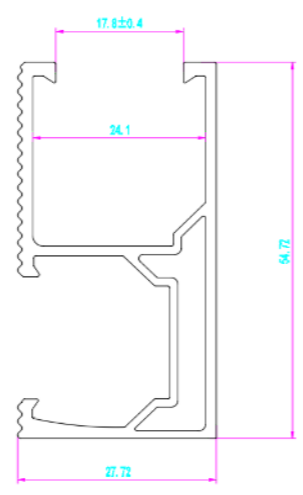

# ATL-IK-TIN

# ATL-IK-TILE

Product CODE	ATL-IK-TIN
Product Name	Antai Tin L Feet
MATERIAL	AL6005-T6 & SS304 Bolt& SUS 410 Screw
SURFACE TREATMENT	ANODIZING 10um, B8 Coating Screw
Package	240pcs/carton, 530*330*330mm
Weight	0.11KG/PC
Contents	1x M8 bolt (25mm) with T nut, 1x ST6.3 (80mm) screw& ruber pad

Product CODE	ATL-IK-TILE
Product Name	Antai Tile Roof Brackets
MATERIAL	SS304 & SUS410
SURFACE TREATMENT	Stainless Steel, B8 coating screw
Package	40pcs/carton, 530*330*330mm
Weight	0.5KG/PC
Contents	1x M8 bolt (25mm) bolt with T nut, 3x ST6.3 (80mm) screws

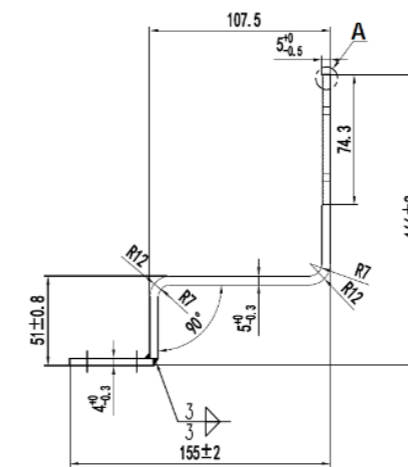
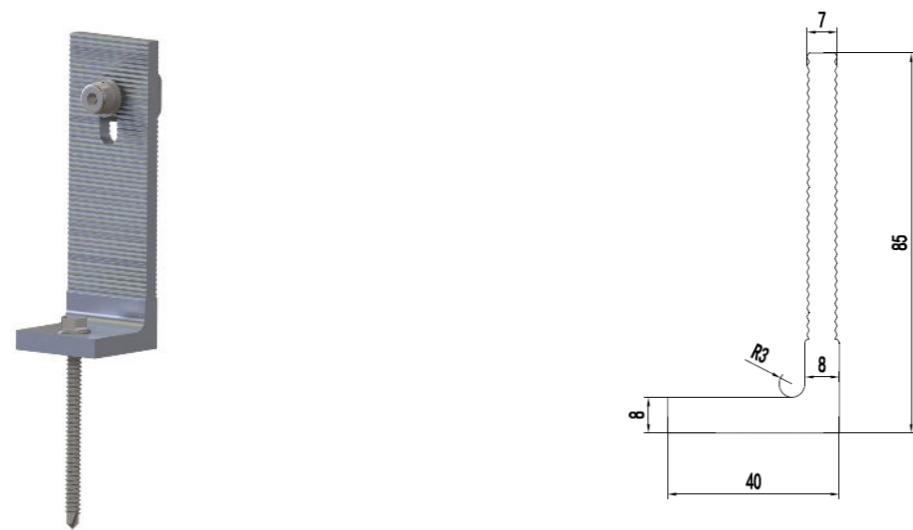

# ATL-AD-FL

# ATL-AD-RL-15/30

<b>Product CODE</b>	ATL-AD-FL
<b>Product Name</b>	Antai Adjustable Front Leg
<b>MATERIAL</b>	AL6005-T6 & SS304 Bolt& SUS 410 Screw
<b>SURFACE TREATMENT</b>	ANODIZING 10um, B8 Coating Screw
<b>Package</b>	10pcs front leg+ 10pcs rear leg/carton, 530*330*330mm
<b>Weight</b>	0.3KG/PC
<b>Contents</b>	1x M8 bolt (25mm) with T nut, 2x ST6.3 (80mm) screws, 1x rubber pad

<b>Product CODE</b>	ATL-AD-RL-15/30
<b>Product Name</b>	Antai Adjustable Rear leg 15/30
<b>MATERIAL</b>	AL6005-T6 & SS304 Bolt& SUS 410 Screw
<b>SURFACE TREATMENT</b>	ANODIZING 10um, B8 Coating Screw
<b>Package</b>	10pcs front leg+ 10pcs rear leg/carton, 530*330*330mm
<b>Weight</b>	0.85KG/PC
<b>Degree</b>	15-30 degree
<b>Contents</b>	1x M8 bolt (25mm) bolt with T nut, 2x ST6.3 (80mm) screws, 1x rubber pad

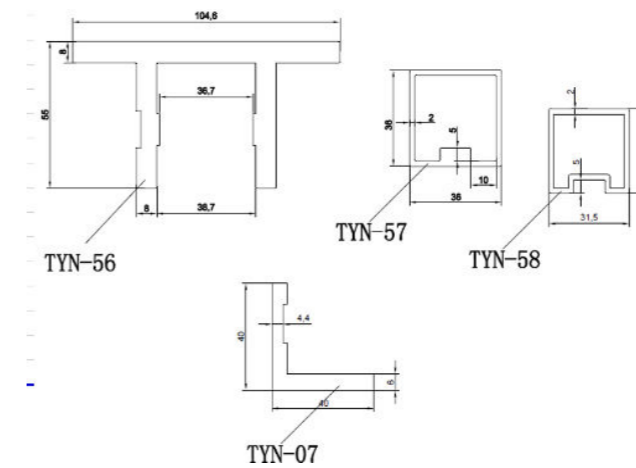
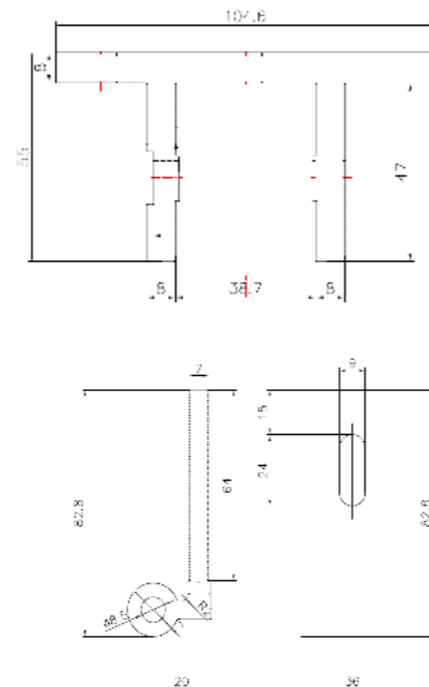



# ATL-AD-RL-10/15

# ATL-IK-700

Product CODE	ATL-AD-RL-10/15
Product Name	Antai Adjustable Rear leg 10/15
MATERIAL	AL6005-T6 & SS304 Bolt& SUS 410 Screw
SURFACE TREATMENT	ANODIZING 10um, B8 Coating Screw
Package	10pcs front leg+ 10pcs rear leg/carton, 530*330*330mm
Weight	0.8KG/PC
Degree	10-15 degree
Contents	1x M8 bolt (25mm) with T nut, 2x ST6.3 (80mm) screws, 1x rubber pad

Product CODE	ATL-IK-700
Product Name	Antai Cliplock 700 Clamp 100mm
MATERIAL	AL6005-T6 & SS304 Bolt
SURFACE TREATMENT	ANODIZING 10um
Package	60pcs/carton, 530*330*330mm
Weight	0.38KG/PC
Length	100mm
Contents	2x M8 bolt (16mm) on the side, 2x M8 bolt (25mm) on the top, 1x EPDM rubber pad

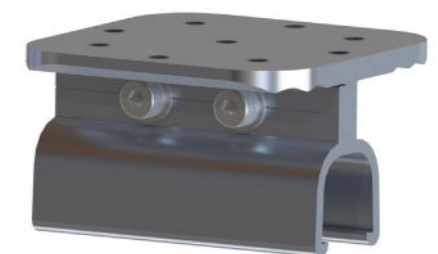
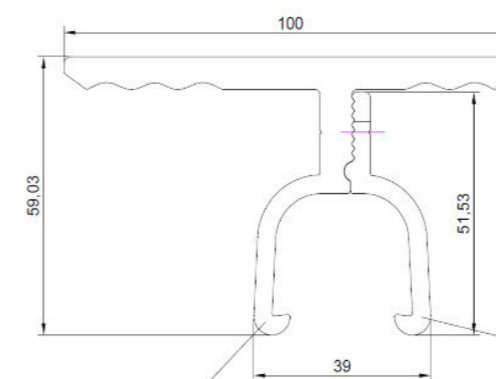
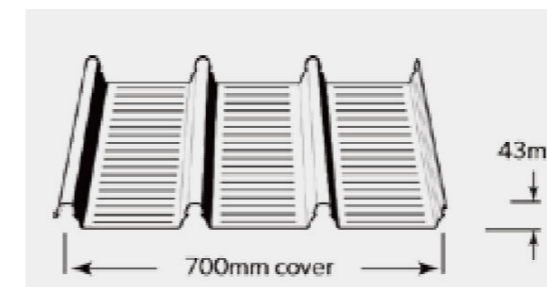
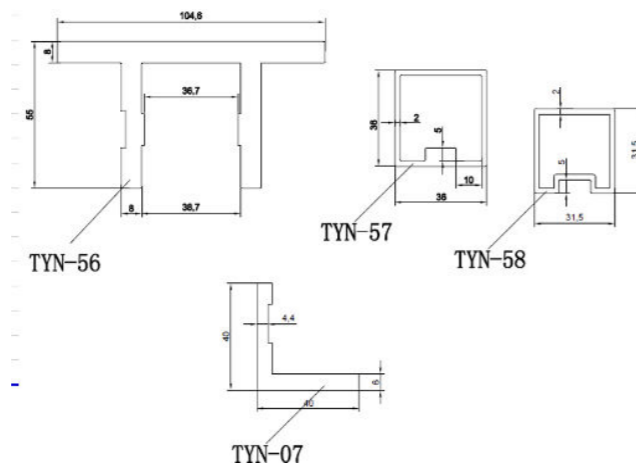

# ATL-IK-406

# ATL-IC-35/40

Product CODE	ATL-IK-406
Product Name	Antai Cliplock 406 Clamp 50mm
MATERIAL	AL6005-T6 & SS304 Bolt
SURFACE TREATMENT	ANODIZING 10um
Package	200pcs/carton, 530*330*330mm
Weight	0.13KG/PC
Length	50mm
Contents	2x M8 bolt (16mm) on the side, 1x M8 bolt (25mm) on the top, 1x EPDM rubber pad

Product CODE	ATL-IC-35/40
Product Name	Antai Mid Clamp 35/40mm
MATERIAL	AL6005-T6 & SS304 Bolt
SURFACE TREATMENT	ANODIZING 10um
Package	400pcs/carton, 530*330*330mm
Weight	0.06KG/PC
Contents	M8 bolt (45mm) & T nut

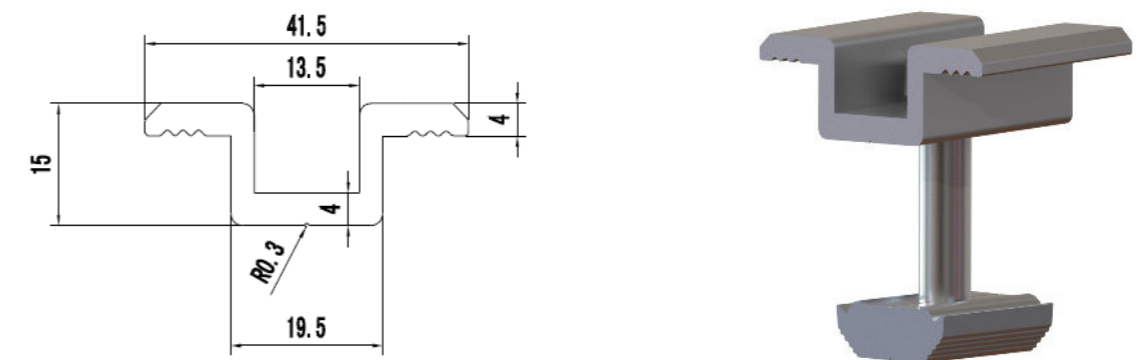
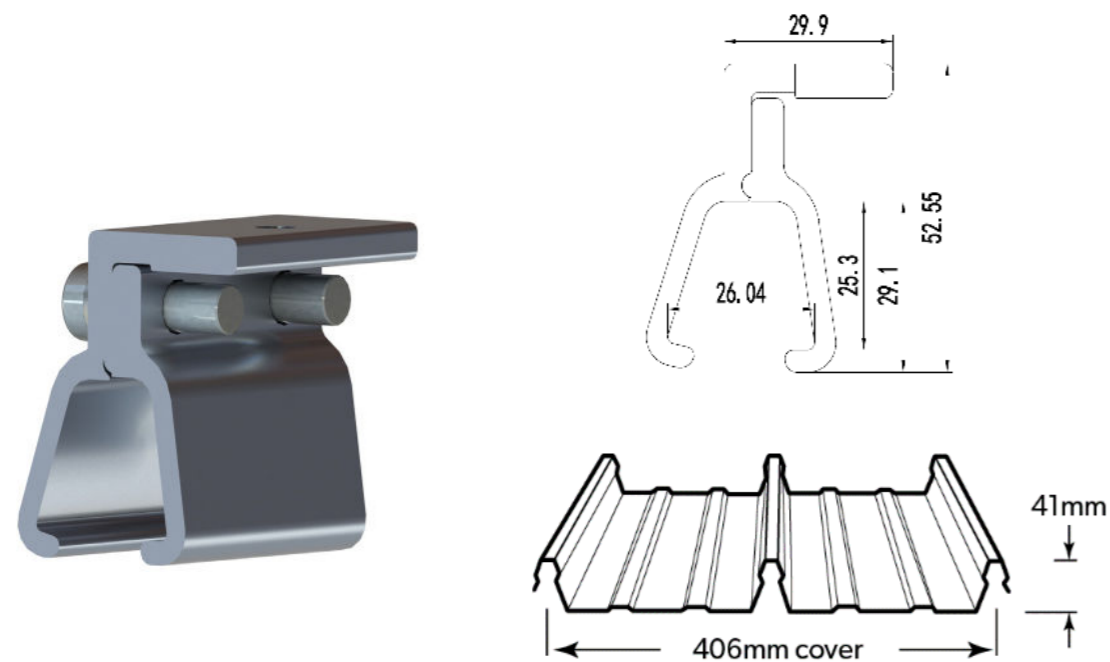

# ATL-IC-35/40-B

Product CODE	ATL-IC-35/40-B
Product Name	Antai Black Mid Clamp 35/40mm
MATERIAL	AL6005-T6 & SS304 Bolt
SURFACE TREATMENT	ANODIZING 10um
Package	400pcs/carton, 530*330*330mm
Weight	0.06KG/PC
Contents	M8 bolt (45mm) & T nut

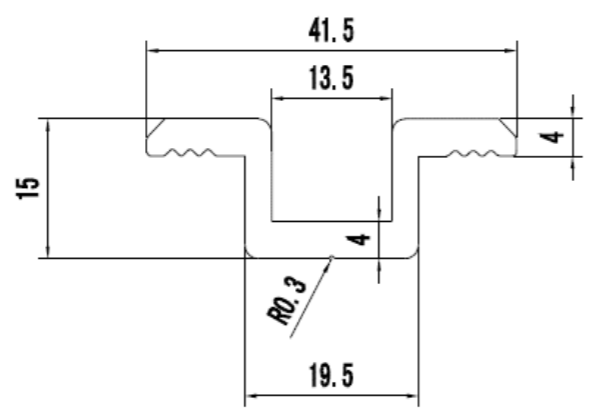

# ATL-EC-35/40-B

Product CODE	ATL-EC-35/40-B
Product Name	Antai Black End Clamp 35/40mm
MATERIAL	AL6005-T6 & SS304 Bolt
SURFACE TREATMENT	ANODIZING 10um
Package	400pcs/carton, 530*330*330mm
Weight	0.06KG/PC
Contents	M8 bolt (30mm) & T nut

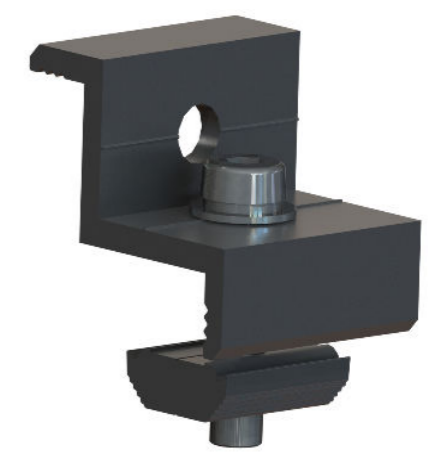
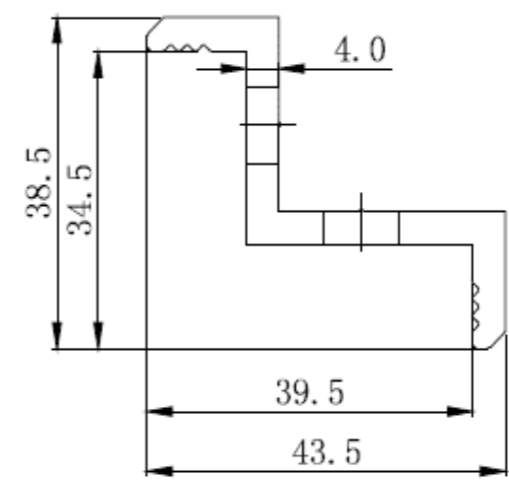



# ATL-EC-35/40

# ALT-EC-32

Product CODE	ATL-EC-35/40
Product Name	Antai End Clamp 35/40mm
MATERIAL	AL6005-T6 & SS304 Bolt
SURFACE TREATMENT	ANODIZING 10um
Package	400pcs/carton, 530*330*330mm
Weight	0.06KG/PC
Contents	M8 bolt (30mm) & T nut

Product CODE	ALT-EC-32
Product Name	Antai End Clamp 32mm
MATERIAL	AL6005-T6 & SS304 Bolt
SURFACE TREATMENT	ANODIZING 10um
Package	400pcs/carton, 530*330*330mm
Weight	0.06KG/PC
Contents	1x M8 bolt (25mm) with T nut

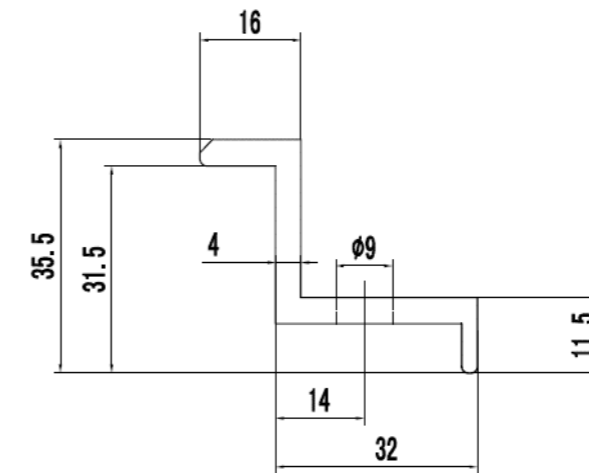
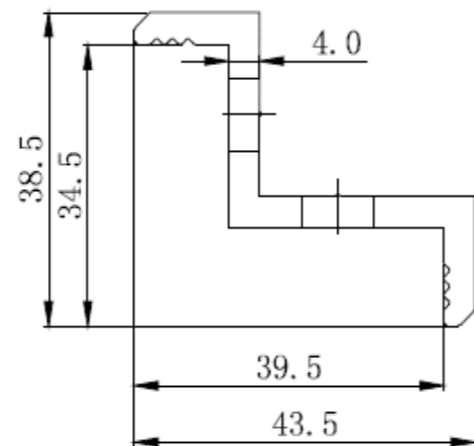
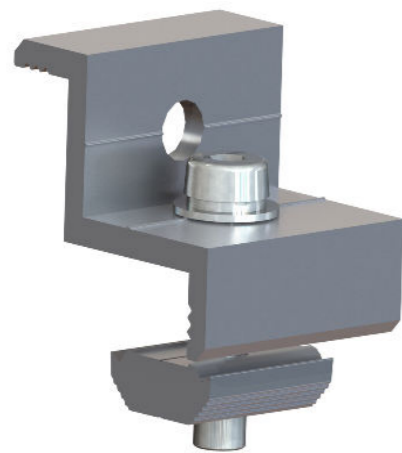

# ALT-EC-42

# ALT-IC-42

Product CODE	ALT-EC-42
Product Name	Antai End Clamp 42mm
MATERIAL	AL6005-T6 & SS304 Bolt
SURFACE TREATMENT	ANODIZING 10um
Package	400pcs/carton, 530*330*330mm
Weight	0.06KG/PC
Contents	1x M8 bolt (30mm) with T nut

Product CODE	ALT-IC-42
Product Name	Antai Mid Clamp 42mm
MATERIAL	AL6005-T6 & SS304 Bolt
SURFACE TREATMENT	ANODIZING 10um
Package	400pcs/carton, 530*330*330mm
Weight	0.06KG/PC
Contents	1x M8 bolt (50mm) with T nut

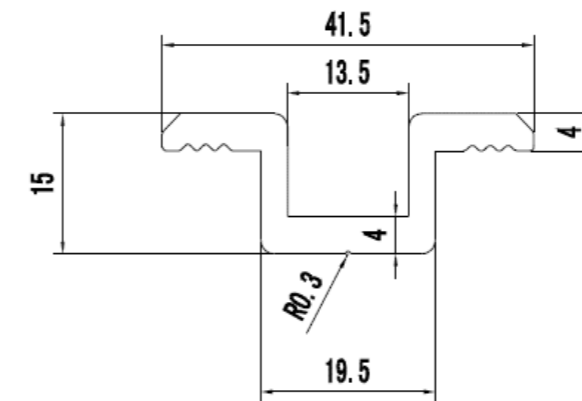
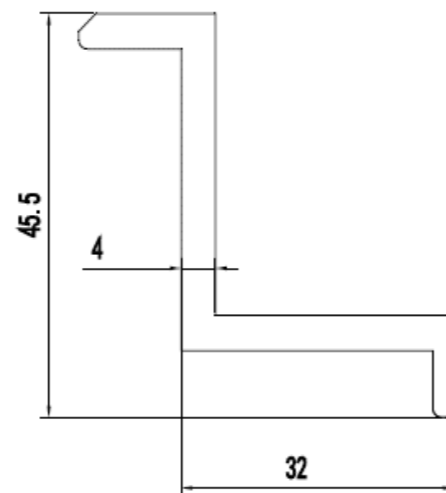

# ATL-EC-30/35

Product CODE	ATL-EC-30/35
Product Name	Antai End Clamp 30/35mm
MATERIAL	AL6005-T6 & SS304 Bolt
SURFACE TREATMENT	ANODIZING 10um
Package	400pcs/carton, 530*330*330mm
Weight	0.06KG/PC
Contents	M8 bolt (30mm) & T nut

# ATL-IC-30/35

Product CODE	ATL-IC-30/35
Product Name	Antai Mid Clamp 30/35mm
MATERIAL	AL6005-T6 & SS304 Bolt
SURFACE TREATMENT	ANODIZING 10um
Package	400pcs/carton, 530*330*330mm
Weight	0.06KG/PC
Contents	M8 bolt (40mm) & T nut

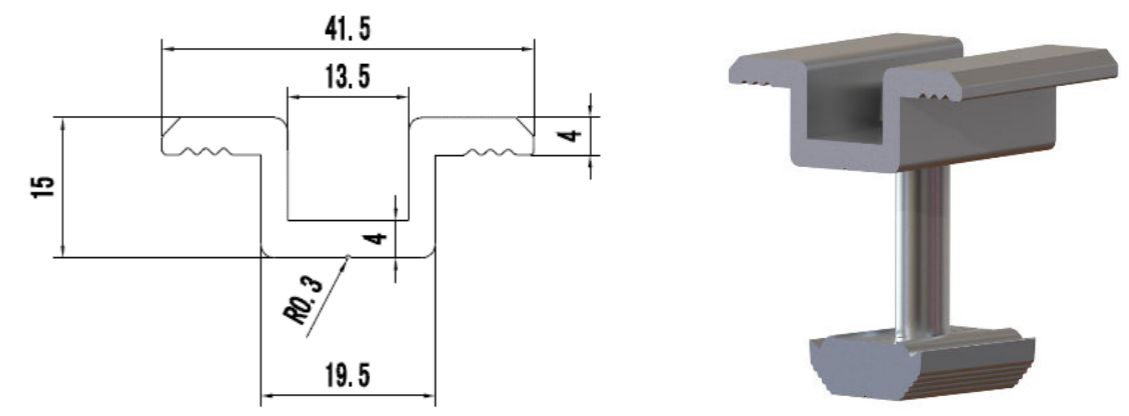
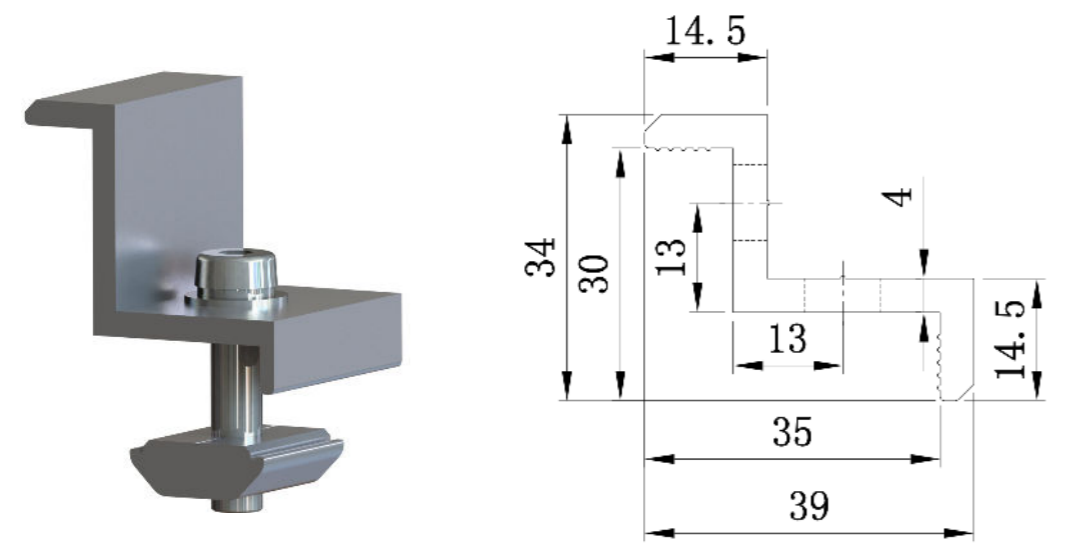

# ATL-IC-30/35-B

Product CODE	ATL-IC-30/35-B
Product Name	BLACK Antai Mid Clamp 30/35mm
MATERIAL	AL6005-T6 & SS304 Bolt
SURFACE TREATMENT	ANODIZING 10um
Package	400pcs/carton, 530*330*330mm
Weight	0.06KG/PC
Contents	M8 bolt (40mm) & T nut

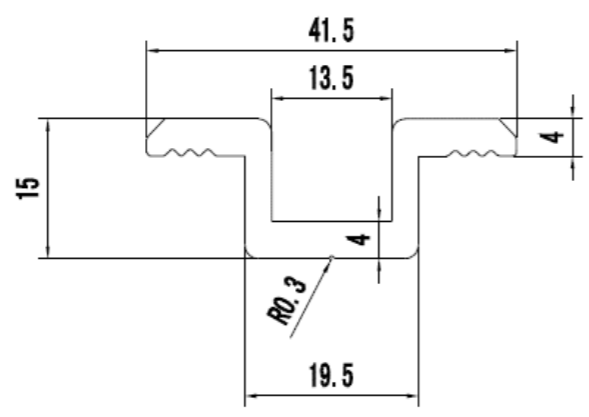

# ATL-EC-30/35-B

Product CODE	ATL-EC-30/35-B
Product Name	BLACK Antai End Clamp 30/35mm
MATERIAL	AL6005-T6 & SS304 Bolt
SURFACE TREATMENT	ANODIZING 10um
Package	400pcs/carton, 530*330*330mm
Weight	0.06KG/PC
Contents	M8 bolt (30mm) & T nut

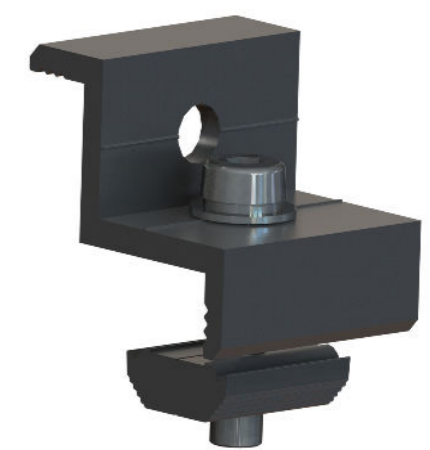
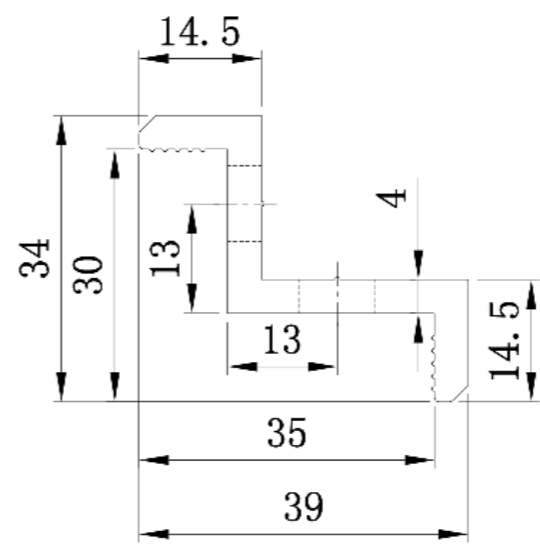



# ATL-Clamp-6P-42

# ATL-Clamp-8P-42

<b>Product CODE</b>	ATL-Clamp-6P-42
<b>Product Name</b>	Antai 6 Panels Clamp Kits 42mm - Only Mid/End Clamps
<b>MATERIAL</b>	AL6005-T6 & SS304 Bolt
<b>SURFACE TREATMENT</b>	ANODIZING 10um
<b>Package</b>	1 set including 4pcs end clamp+10pcs mid clamp 32 sets/master carton, 530*330*330mm
<b>Weight</b>	0.85KGS/Set, 26KGS/Master carton
<b>Contents</b>	ATL-EC-42(Antai End Clamp 42mm) x 4pcs ATL-IC-42(Antai Mid Clamp 40/42mm )x 10pcs

<b>Product CODE</b>	ATL-Clamp-8P-42
<b>Product Name</b>	Antai 8 Panels Clamp Kits 42mm - Only Mid/End Clamps
<b>MATERIAL</b>	AL6005-T6 & SS304 Bolt
<b>SURFACE TREATMENT</b>	ANODIZING 10um
<b>Package</b>	1 set including 8pcs end clamp+14pcs mid clamp 20 sets/master carton, 530*330*330mm
<b>Weight</b>	1.3KGS/Set, 26KGS/Master carton
<b>Contents</b>	ATL-EC-42(Antai End Clamp 42mm) x 8pcs ATL-IC-42(Antai Mid Clamp 40/42mm )x 14pcs

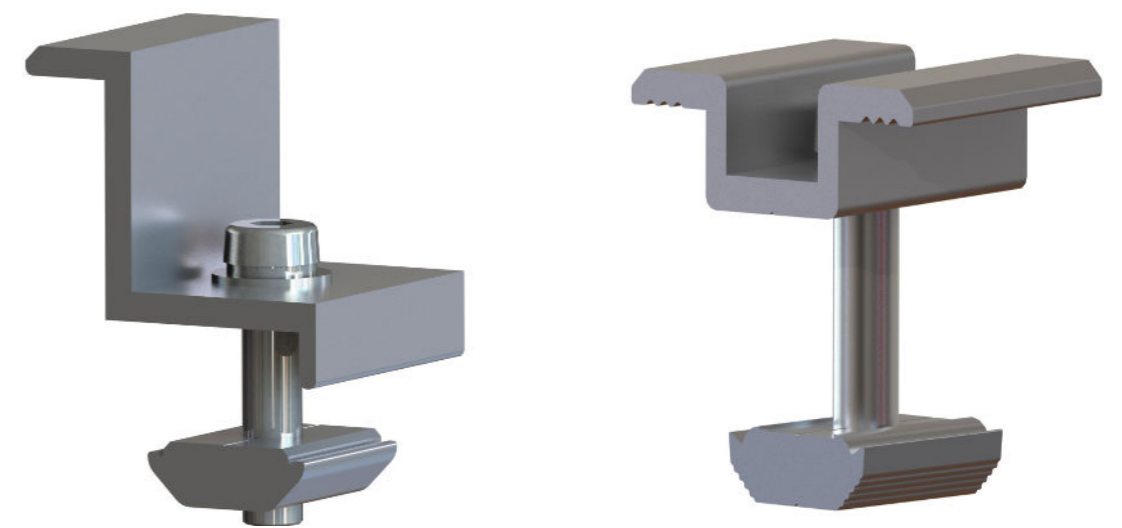
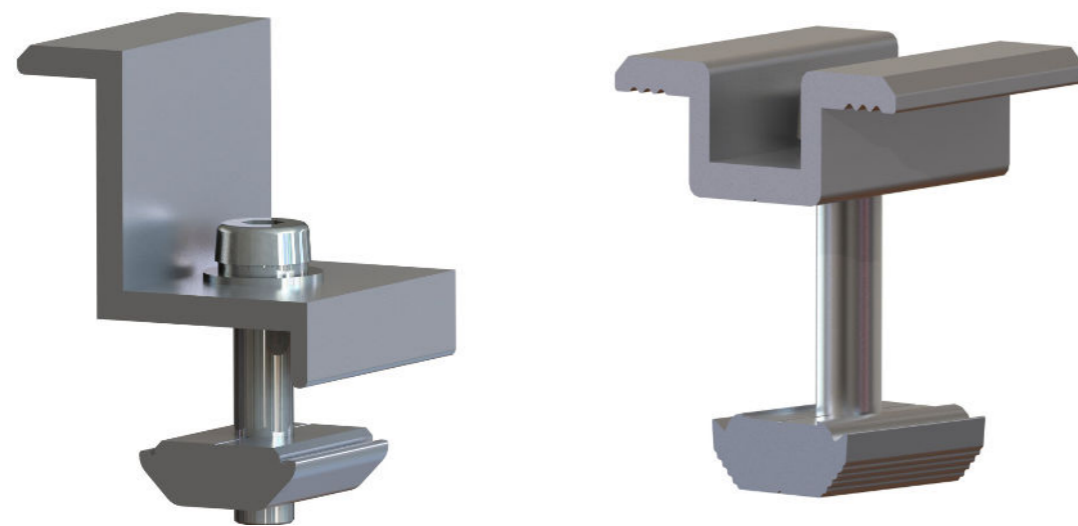

# ATL-DR-Nut

# ATL-G-EC

Product CODE	ATL-DR-Nut
Product Name	Antai Compatible Bolt and Nut Kit
MATERIAL	AL6005-T6 & SS304 Bolt
SURFACE TREATMENT	ANODIZING 10um
Package	1000pcs/carton, 530*330*330mm
Weight	0.02KG/PC
Contents	1x M8 bolt (25mm) with T nut

Product CODE	ATL-G-EC
Product Name	Antai Earthing Clip
MATERIAL	SS304
SURFACE TREATMENT	Stainless Steel
Package	4500pcs/carton, 530*330*330mm
Weight	0.01KG/PC

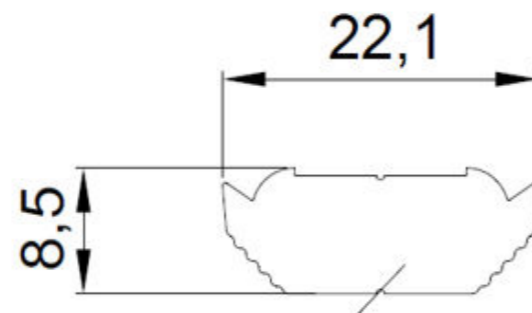
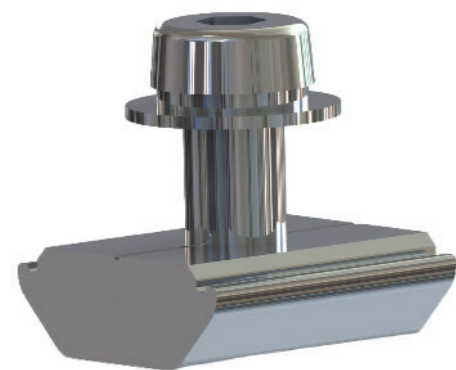

# ATL-CT-2

# ATL-G-GL





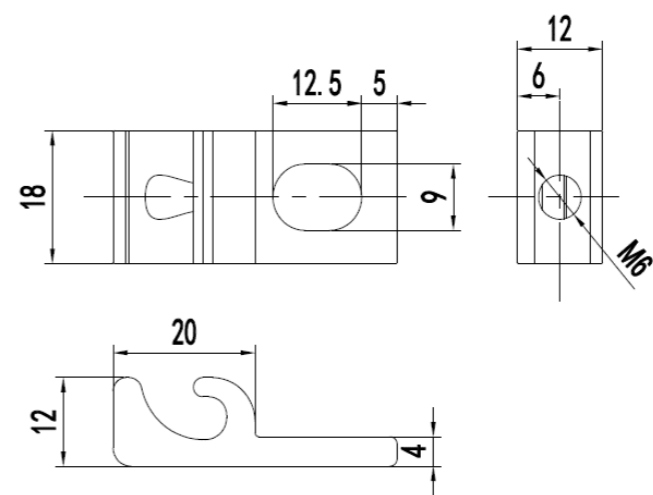
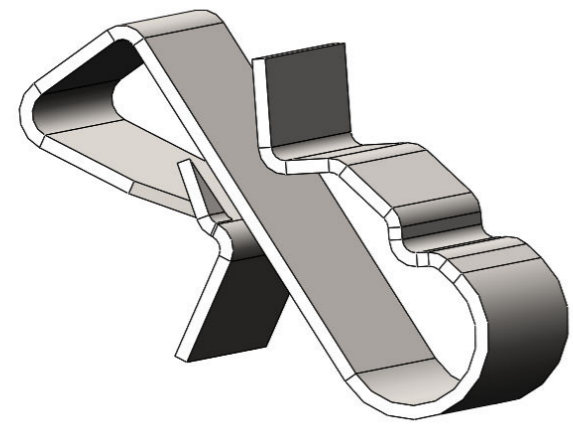

Product CODE	ATL-CT-2
Product Name	Antai Cable Clip
MATERIAL	SS304
SURFACE TREATMENT	Stainless Steel
Package	5000pcs/carton, 530*330*330mm
Weight	0.01KG/PC
Application	1-2pcs Cables, Cable DIA 5.0-6.5mm







Product CODE	ATL-G-GL
Product Name	Antai Grounding Lug
MATERIAL	Copper Lug& AL6005-T6 & SS304 Bolt
SURFACE TREATMENT	ANODIZING 10um
Package	800pcs/carton, 530*330*330mm
Weight	0.06KG/PC
Contents	1x M8 bolt (25mm) with T nut, 1x M8 bolt (16mm)



# ATL-Tin-1500-35/40

# ATL-Tin-2000-35/40

<b>Product CODE</b>	ATL-Tin-1500-35/40
<b>Product Name</b>	Antai 1.5KW Tin Kit 35/40mm
<b>MATERIAL</b>	AL6005-T6 & SS304 Bolt
<b>SURFACE TREATMENT</b>	ANODIZING 10um
<b>Package</b>	1 set/ inner carton, 260*195*100mm 4 sets/master carton, 540*205*220mm
<b>Weight</b>	2.9KGS/Inner carton, 11.6KGS/Master carton
<b>Contents</b>	ATL-IC-35/40(Antai Mid Clamp 35/40mm) x 10pcs ATL-EC-35/40(Antai End Clamp 35/40mm)x 4pcs ATL-G-EC(Antai Earthing Clip)x 10pcs ATL-DR-JOINER(Antai T Universal Rail Splice) x2pcs ATL-IK-TIN(Antai Tin L Feet)x 12pcs ATL-G-GL(Antai Grounding Lug)x2pcs
<b>Tin35/40 Standard 1.5Kw Kit</b>	 x 12  x 10  x 10  x 4  x 2  x 2





<b>Product CODE</b>	ATL-Tin-2000-35/40
<b>Product Name</b>	Antai 2.0KW Tin Kit 35/40mm
<b>MATERIAL</b>	AL6005-T6 & SS304 Bolt
<b>SURFACE TREATMENT</b>	ANODIZING 10um
<b>Package</b>	1 set/ inner carton, 260*195*100mm 4 sets/master carton, 540*205*220mm
<b>Weight</b>	3.9KGS/Inner carton, 15.6KGS/Master carton
<b>Contents</b>	ATL-IC-35/40(Antai Mid Clamp 35/40mm) x 14pcs ATL-EC-35/40(Antai End Clamp 35/40mm)x 8pcs ATL-G-EC(Antai Earthing Clip)x 14pcs ATL-DR-JOINER(Antai T Universal Rail Splice) x2pcs ATL-IK-TIN(Antai Tin L Feet)x 16pcs ATL-G-GL(Antai Grounding Lug)x2pcs
<b>Tin35/40 Standard 2Kw Kit</b>	 x 16  x 14  x 14  x 8  x 2  x 2



# ATL-Tile-1500-35/40







# ATL-Tile-2000-35/40



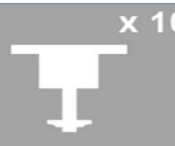

<b>Product CODE</b>	ATL-Tile-1500-35/40
<b>Product Name</b>	Antai 1.5KW Tile Kit 35/40mm
<b>MATERIAL</b>	AL6005-T6 & SS304 Bolt
<b>SURFACE TREATMENT</b>	ANODIZING 10um
<b>Package</b>	1 set/ inner carton, 260*195*160mm 4 sets/master carton, 540*205*340mm
<b>Weight</b>	8.4KGS/Inner carton, 33.6KGS/Master carton
<b>Contents</b>	ATL-IC-35/40(Antai Mid Clamp 35/40mm) x 10pcs ATL-EC-35/40(Antai End Clamp 35/40mm)x 4pcs ATL-G-EC(Antai Earthing Clip)x 10pcs ATL-DR-JOINER(Antai T Universal Rail Splice) x2pcs ATL-IK-TILE(Antai Tile Roof Brackets)x 12pcs ATL-G-GL(Antai Grounding Lug)x2pcs
<b>Tile35/40 Standard 1.5Kw Kit</b>	 x 12  x 10  x 10  x 4  x 2  x 2

<b>Product CODE</b>	ATL-Tile-2000-35/40
<b>Product Name</b>	Antai 2.0KW Tile Kit 35/40mm
<b>MATERIAL</b>	AL6005-T6 & SS304 Bolt
<b>SURFACE TREATMENT</b>	ANODIZING 10um
<b>Package</b>	1 set/ inner carton, 260*195*195mm 2 sets/master carton, 540*205*215mm
<b>Weight</b>	11.3KGS/Inner carton, 22.6KGS/Master carton
<b>Contents</b>	ATL-IC-35/40(Antai Mid Clamp 35/40mm) x 14pcs ATL-EC-35/40(Antai End Clamp 35/40mm)x 8pcs ATL-G-EC(Antai Earthing Clip)x 14pcs ATL-DR-JOINER(Antai T Universal Rail Splice) x2pcs ATL-IK-TILE(Antai Tile Roof Brackets)x 16pcs ATL-G-GL(Antai Grounding Lug)x2pcs
<b>Tile35/40 Standard 2Kw Kit</b>	 x 16  x 14  x 14  x 8  x 2  x 2

# ATL-Tin-1500-35/40-B







# ATL-Tin-2000-35/40-B



<b>Product CODE</b>	BLACK Antai 1.5KW Tin Kit 35/40mm
<b>Product Name</b>	Antai 1.5KW Tile Kit 35/40mm
<b>MATERIAL</b>	AL6005-T6 & SS304 Bolt
<b>SURFACE TREATMENT</b>	ANODIZING 10um
<b>Package</b>	1 set/ inner carton, 260*195*160mm 4 sets/master carton, 540*205*340mm
<b>Weight</b>	2.9KGS/Inner carton, 11.6KGS/Master carton
<b>Contents</b>	ATL-IC-35/40-B (BLACK Antai Mid Clamp 35/40mm) x 10pcs ATL-EC-35/40-B (BLACK Antai End Clamp 35/40mm)x 4pcs ATL-G-EC(Antai Earthing Clip)x 10pcs ATL-DR-JOINER(Antai T Universal Rail Splice) x2pcs ATL-IK-TILE(Antai Tile Roof Brackets)x 12pcs ATL-G-GL(Antai Grounding Lug)x2pcs
<b>Tin 35/40 Standard 1.5Kw Kit</b>	 x 12  x 10  x 10  x 4  x 2  x 2

<b>Product CODE</b>	ATL-Tin-2000-35/40-B
<b>Product Name</b>	BLACK Antai 2.0KW Tin Kit 35/40mm
<b>MATERIAL</b>	AL6005-T6 & SS304 Bolt
<b>SURFACE TREATMENT</b>	ANODIZING 10um
<b>Package</b>	1 set/ inner carton, 260*195*195mm 4 sets/master carton, 540*205*215mm
<b>Weight</b>	3.9KGS/Inner carton, 15.6KGS/Master carton
<b>Contents</b>	ATL-IC-35/40-B(BLACK Antai Mid Clamp 35/40mm) x 14pcs ATL-EC-35/40-B(BLACK Antai End Clamp 35/40mm)x 8pcs ATL-G-EC(Antai Earthing Clip)x 14pcs ATL-DR-JOINER(Antai T Universal Rail Splice) x2pcs ATL-IK-TILE(Antai Tile Roof Brackets)x 16pcs ATL-G-GL(Antai Grounding Lug)x2pcs
<b>Tin 35/40 Standard 2Kw Kit</b>	 x 16  x 14  x 14  x 8  x 2  x 2

# ATL-Tile-1500-35/40-B







# ATL-Tile-2000-35/40-B

<b>Product CODE</b>	ATL-Tile-1500-35/40-B
<b>Product Name</b>	BALCK Antai 1.5KW Tile Kit 35/40mm
<b>MATERIAL</b>	AL6005-T6 & SS304 Bolt
<b>SURFACE TREATMENT</b>	ANODIZING 10um
<b>Package</b>	1 set/ inner carton, 260*195*160mm 4 sets/master carton, 540*205*340mm
<b>Weight</b>	8.4KGS/Inner carton, 33.6KGS/Master carton
<b>Contents</b>	ATL-IC-35/40-B (BLACK Antai Mid Clamp 35/40mm) x 10pcs ATL-EC-35/40-B (BLACK Antai End Clamp 35/40mm)x 4pcs ATL-G-EC(Antai Earthing Clip)x 10pcs ATL-DR-JOINER(Antai T Universal Rail Splice) x2pcs ATL-IK-TILE(Antai Tile Roof Brackets)x 12pcs ATL-G-GL(Antai Grounding Lug)x2pcs
<b>Tile35/40 Standard 1.5Kw Kit</b>	 x 12  x 10  x 10  x 4  x 2  x 2

<b>Product CODE</b>	ATL-Tile-2000-35/40-B
<b>Product Name</b>	BLACK Antai 2.0KW Tile Kit 35/40mm
<b>MATERIAL</b>	AL6005-T6 & SS304 Bolt
<b>SURFACE TREATMENT</b>	ANODIZING 10um
<b>Package</b>	1 set/ inner carton, 260*195*195mm 2 sets/master carton, 540*205*215mm
<b>Weight</b>	11.3KGS/Inner carton, 22.6KGS/Master carton
<b>Contents</b>	ATL-IC-35/40-B(BLACK Antai Mid Clamp 35/40mm) x 14pcs ATL-EC-35/40-B(BLACK Antai End Clamp 35/40mm)x 8pcs ATL-G-EC(Antai Earthing Clip)x 14pcs ATL-DR-JOINER(Antai T Universal Rail Splice) x2pcs ATL-IK-TILE(Antai Tile Roof Brackets)x 16pcs ATL-G-GL(Antai Grounding Lug)x2pcs
<b>Tile35/40 Standard 2Kw Kit</b>	 x 16  x 14  x 14  x 8  x 2  x 2

# ATL-Tin-1500-30/35-B

# ATL-Tin-2000-30/35-B







<b>Product CODE</b>	ATL-Tin-1500-30/35-B
<b>Product Name</b>	BLACK Antai 1.5KW Tin Kit 30/35mm
<b>MATERIAL</b>	AL6005-T6 & SS304 Bolt
<b>SURFACE TREATMENT</b>	ANODIZING 10um
<b>Package</b>	1 set/ inner carton, 260*195*160mm 4 sets/master carton, 540*205*340mm
<b>Weight</b>	2.9KGS/Inner carton, 11.6KGS/Master carton
<b>Contents</b>	ATL-IC-30/35-B (BLACK Antai Mid Clamp 30/35mm) x 10pcs ATL-EC-30/35-B (BLACK Antai End Clamp 30/35mm)x 4pcs ATL-G-EC(Antai Earthing Clip)x 10pcs ATL-DR-JOINER(Antai T Universal Rail Splice) x2pcs ATL-IK-TILE(Antai Tile Roof Brackets)x 12pcs ATL-G-GL(Antai Grounding Lug)x2pcs
<b>Tin 30/35 Standard 1.5Kw Kit</b>	     



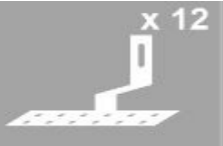

<b>Product CODE</b>	ATL-Tin-2000-30/35-B
<b>Product Name</b>	BLACK Antai 2.0KW Tile Kit 35/40mm
<b>MATERIAL</b>	AL6005-T6 & SS304 Bolt
<b>SURFACE TREATMENT</b>	ANODIZING 10um
<b>Package</b>	1 set/ inner carton, 260*195*195mm 4 sets/master carton, 540*205*215mm
<b>Weight</b>	3.9KGS/Inner carton, 15.6KGS/Master carton
<b>Contents</b>	ATL-IC-30/35-B(BLACK Antai Mid Clamp 30/35mm) x 14pcs ATL-EC-30/35-B(BLACK Antai End Clamp 30/35mm)x 8pcs ATL-G-EC(Antai Earthing Clip)x 14pcs ATL-DR-JOINER(Antai T Universal Rail Splice) x2pcs ATL-IK-TILE(Antai Tile Roof Brackets)x 16pcs ATL-G-GL(Antai Grounding Lug)x2pcs
<b>Tin30/35 Standard 2Kw Kit</b>	     



# ATL-Tile-1500-30/35-B



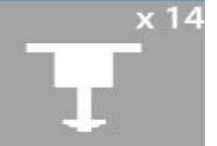



# ATL-Tile-2000-30/35-B







<b>Product CODE</b>	ATL-Tile-1500-30/35-B
<b>Product Name</b>	BLACK Antai 1.5KW Tin Kit 30/35mm
<b>MATERIAL</b>	AL6005-T6 & SS304 Bolt
<b>SURFACE TREATMENT</b>	ANODIZING 10um
<b>Package</b>	1 set/ inner carton, 260*195*160mm 4 sets/master carton, 540*205*340mm
<b>Weight</b>	8.4KGS/Inner carton, 33.6KGS/Master carton
<b>Contents</b>	ATL-IC-30/35-B (BLACK Antai Mid Clamp 30/35mm) x 10pcs ATL-EC-30/35-B (BLACK Antai End Clamp 30/35mm)x 4pcs ATL-G-EC(Antai Earthing Clip)x 10pcs ATL-DR-JOINER(Antai T Universal Rail Splice) x2pcs ATL-IK-TILE(Antai Tile Roof Brackets)x 12pcs ATL-G-GL(Antai Grounding Lug)x2pcs
<b>Tile30/35 Standard 1.5Kw Kit</b>	     

<b>Product CODE</b>	ATL-Tile-2000-30/35-B
<b>Product Name</b>	BLACK Antai 2.0KW Tile Kit 35/40mm
<b>MATERIAL</b>	AL6005-T6 & SS304 Bolt
<b>SURFACE TREATMENT</b>	ANODIZING 10um
<b>Package</b>	1 set/ inner carton, 260*195*195mm 2 sets/master carton, 540*205*215mm
<b>Weight</b>	11.3KGS/Inner carton, 22.6KGS/Master carton
<b>Contents</b>	ATL-IC-30/35-B(BLACK Antai Mid Clamp 30/35mm) x 14pcs ATL-EC-30/35-B(BLACK Antai End Clamp 30/35mm)x 8pcs ATL-G-EC(Antai Earthing Clip)x 14pcs ATL-DR-JOINER(Antai T Universal Rail Splice) x2pcs ATL-IK-TILE(Antai Tile Roof Brackets)x 16pcs ATL-G-GL(Antai Grounding Lug)x2pcs
<b>Tile30/35 Standard 2Kw Kit</b>	     

# ATL-Tin-1500-30/35







# ATL-Tin-2000-30/35

<b>Product CODE</b>	ATL-Tin-1500-30/35
<b>Product Name</b>	Antai 1.5KW Tin Kit 30/35mm
<b>MATERIAL</b>	AL6005-T6 & SS304 Bolt
<b>SURFACE TREATMENT</b>	ANODIZING 10um
<b>Package</b>	1 set/ inner carton, 260*195*160mm 4 sets/master carton, 540*205*340mm
<b>Weight</b>	2.9KGS/Inner carton, 11.6KGS/Master carton
<b>Contents</b>	ATL-IC-35/40(Antai Mid Clamp 35/40mm) x 10pcs ATL-EC-35/40(Antai End Clamp 35/40mm)x 4pcs ATL-G-EC(Antai Earthing Clip)x 10pcs ATL-DR-JOINER(Antai T Universal Rail Splice) x2pcs ATL-IK-TILE(Antai Tile Roof Brackets)x 12pcs ATL-G-GL(Antai Grounding Lug)x2pcs
<b>Tin 30/35 Standard 1.5Kw Kit</b>	 x 12  x 10  x 10  x 4  x 2  x 2

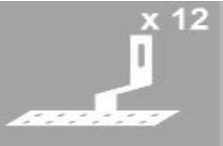
<b>Product CODE</b>	ATL-Tin-2000-30/35
<b>Product Name</b>	Antai 2.0KW Tile Kit 35/40mm
<b>MATERIAL</b>	AL6005-T6 & SS304 Bolt
<b>SURFACE TREATMENT</b>	ANODIZING 10um
<b>Package</b>	1 set/ inner carton, 260*195*195mm 4 sets/master carton, 540*205*215mm
<b>Weight</b>	3.9KGS/Inner carton, 15.6KGS/Master carton
<b>Contents</b>	ATL-IC-35/40(Antai Mid Clamp 35/40mm) x 14pcs ATL-EC-35/40(Antai End Clamp 35/40mm)x 8pcs ATL-G-EC(Antai Earthing Clip)x 14pcs ATL-DR-JOINER(Antai T Universal Rail Splice) x2pcs ATL-IK-TILE(Antai Tile Roof Brackets)x 16pcs ATL-G-GL(Antai Grounding Lug)x2pcs
<b>Tin 30/35 Standard 2Kw Kit</b>	 x 16  x 14  x 14  x 8  x 2  x 2

# ATL-Tile-1500-30/35

# ATL-Tile-2000-30/35

<b>Product CODE</b>	ATL-Tin-1500-30/35
<b>Product Name</b>	Antai 1.5KW Tile Kit 30/35mm
<b>MATERIAL</b>	AL6005-T6 & SS304 Bolt
<b>SURFACE TREATMENT</b>	ANODIZING 10um
<b>Package</b>	1 set/ inner carton, 260*195*160mm 4 sets/master carton, 540*205*340mm
<b>Weight</b>	8.4KGS/Inner carton, 33.6KGS/Master carton
<b>Contents</b>	ATL-IC-35/40(Antai Mid Clamp 35/40mm) x 10pcs ATL-EC-35/40(Antai End Clamp 35/40mm)x 4pcs ATL-G-EC(Antai Earthing Clip)x 10pcs ATL-DR-JOINER(Antai T Universal Rail Splice) x2pcs ATL-IK-TILE(Antai Tile Roof Brackets)x 12pcs ATL-G-GL(Antai Grounding Lug)x2pcs
<b>Tile30/35 Standard 1.5Kw Kit</b>	     

<b>Product CODE</b>	ATL-Tile-2000-30/35
<b>Product Name</b>	Antai 2.0KW Tile Kit 30/35mm
<b>MATERIAL</b>	AL6005-T6 & SS304 Bolt
<b>SURFACE TREATMENT</b>	ANODIZING 10um
<b>Package</b>	1 set/ inner carton, 260*195*195mm 2 sets/master carton, 540*205*215mm
<b>Weight</b>	11.3KGS/Inner carton, 22.6KGS/Master carton
<b>Contents</b>	ATL-IC-35/40(Antai Mid Clamp 35/40mm) x 14pcs ATL-EC-35/40(Antai End Clamp 35/40mm)x 8pcs ATL-G-EC(Antai Earthing Clip)x 14pcs ATL-DR-JOINER(Antai T Universal Rail Splice) x2pcs ATL-IK-TILE(Antai Tile Roof Brackets)x 16pcs ATL-G-GL(Antai Grounding Lug)x2pcs
<b>Tile30/35 Standard 2Kw Kit</b>	    